



**NEW!** SMOOTHER OPENING

Document Q Compliant

**aspect**<sup>®</sup>

Beautifully designed, easy to  
install PVC-U bi-fold doors

**eurocell**<sup>®</sup>  
All together better



Image courtesy of Lissett Homes

**aspect®**

VISUALLY STUNNING FOLDING SLIDING DOORS HAVE NEVER BEEN SO EASY TO FABRICATE AND FIT

The first bi-fold door on the UK market to achieve BBA certification and Secured by Design accreditation

### **Architectural door style in demand**

As homeowners and housebuilders seek to improve their homes and inject that elusive 'wow' factor, the stunning bi-fold style of door has become an increasingly popular choice. Panoramic doors enable large glazed 'walls' to be created, flooding interiors with natural light and bringing the outside into the home. The concertina-style folding and sliding design enables the entire doorway to be opened up, seamlessly integrating indoor and outdoor spaces.

### **Aspect makes aspirations a reality**

To help fabricators and installers meet this growing demand, Eurocell developed Aspect – a high-performance, secure and visually stunning PVC-U bi-fold door system that's designed for hassle-free fabrication and fitting. Aspect offers all the aesthetic and functional benefits of timber and aluminium alternatives, but at a more affordable price. It incorporates a host of intelligently designed and precision-engineered bespoke components that enable accurate, consistent, straightforward fabrication and installation.

## WHY CHOOSE ASPECT?



**Purpose-designed system for superior performance**



**Fast, accurate installation**



**U-values as low as 0.9\***



**Patented features for superior looks**



**BBA certified and Secured By Design approved**



**Cheaper than aluminium and timber alternatives**



**Bespoke British designed hardware**



**10-year guarantee for peace of mind**

### Performance and price to set your business apart

Whether you're a fabricator or installer, Aspect enables you to set your business apart from the competition by offering your customers market-leading, quality-assured, lifestyle-enhancing PVC-U bi-fold doors at attractive prices.

### Fully accredited

Eurocell pushes the boundaries of design and performance in the bi-fold door category with it being the first of few bi-fold doors on the UK market to gain BBA accreditation and Secured by Design status.

Meeting the requirements of these two important standards means that Aspect bi-fold doors are perfect for all new build applications, where Secured by Design is being specified to meet the requirements of Approved Document Q.



Certificate number  
13/5043



\* For triple glazed door. 1.3 for double glazed door





## INTELLIGENT DESIGN

CREATES THE LEADING PVC-U BI-FOLD DOOR SYSTEM

### Aesthetics

- ▶ Door openings can be up to six metres wide, with up to seven door panels. The unique roller assembly means doors can be configured to meet customer preferences, including the popular 4/2/2 configuration as well as simple 2/2/0 arrangements to replace existing patio doors.
- ▶ A patented trim conceals unsightly black gaskets between door leaves, creating a clean, attractive finish.
- ▶ Doors require no dummy mullion – a patented feature – creating an uncluttered door finish with equal sight lines to rival any bi-fold door on the market.
- ▶ Doors can be fitted with midrails and letter plates for front entrances, and can even incorporate opening sashes within the door.
- ▶ Attractive, unobtrusive D-handle fits flat to the door frame, enabling opened door leaves to sit neatly side by side – maximising the size of the door opening.
- ▶ Compatible with Eurocell Eurologik window and conservatory systems.
- ▶ Optional roller track brush pile for improved aesthetics.

## Functionality

- ▶ Bi-directional stainless steel roller track and wheels provide smooth opening and superior glide door operation
- ▶ Unique Eurocell D-handle engages top and bottom shoot bolts, and is specially engineered to prevent bolts being accidentally engaged when the doors are open. Damaged shoot bolts are the primary cause of rectification for bi-fold doors, resulting from doors being closed with shoot bolts already engaged.
- ▶ In-built rollers for a minimised threshold height as standard.
- ▶ Flush fitting internal room dividing threshold available.
- ▶ Part-M threshold double ramp available.
- ▶ Unobtrusive, finger-operated shoot bolt for traffic door leaves – designed for easy operation to engage both top and bottom shoot bolts.
- ▶ Angled threshold drip trim contoured to expel water and maintain excellent weather tightness (can also be reversed to act as a head drip trim).
- ▶ Magnetic door stops keep doors neatly folded back.

## Security

- ▶ Rollers are captive within the track, so that doors cannot be removed by force from the outside.
- ▶ All sashes are steel reinforced for superior strength and rigidity.

## Fully accredited

- ▶ The first bi-fold door of any material on the UK market to gain BBA certification.
- ▶ BS 6375 and PAS 24 accredited.
- ▶ Secured By Design status has been achieved.



# MARKET-LEADING FEATURES



**Horizontal rollers**  
x4

**Vertical stainless steel wheels**  
x4

Superior glide from four horizontal rollers and four vertical stainless steel wheels - 8 in total



**Trim to conceal gaskets**



**No dummy mullion needed**



**Unique D-handle**



**Bespoke British designed and manufactured hardware**



**Part M threshold available**



**In-built bi-directional roller system**





**Finger-operated shootbolts**



**Combined wool-pile and gasket slots**



**Slim-stepped outer frame with anodised aluminium track**



**Co-extruded glazing gaskets**



**'Grab' hinge handle aids the opening and closing of multiple door leaves**



**Magnetic door stops for a neat fold**



## FABRICATION

### FAST, EFFICIENT AND CONSISTENT

As a market-leading manufacturer of PVC-U profiles, Eurocell understands that to remain competitive fabricators and installers need high-quality products designed for simple, fast, accurate fabrication and fitting.

We know that if you can quickly and repeatedly complete jobs to a high standard, you will keep your costs down, improve your profit margins and keep your customers happy. You'll also have fewer rectification call-outs once the job is finished.

That's why Aspect panoramic doors have been purpose-designed by Eurocell's technical specialists to include a host of features that enable quick and simple fabrication and fitting, without compromising on the quality or appearance of these stunning bi-fold doors. Here are just a few of the built-in benefits for fabricators and installers:

#### **Minimal welding, cutting and trimming**

The Aspect profile system is designed for bi-fold door fabrication. That means minimal welding, cutting and trimming for you – and a better quality, more consistent finish to every panoramic door for your customers.

#### **Compatible components for simplified stockholding**

Doors feature a standard Eurocell Eurologik gasket and are compatible with our patented Eurologik chamfered and ovolo beads – so if you're already fabricating Eurologik windows and doors, there's no need for additional stockholding.

#### **Integral gaskets save time and money**

The door profile and outer frame glazing gaskets are co-extruded, so you won't have to buy gaskets separately and fit them yourself – saving you time and money.

#### **Fewer components for faster fabrication**

Aspect has been designed with no need for a dummy mullion, reducing the number of components you need to fit – for faster, more efficient fabrication.

#### **Single roller-track colour for all door options**

A neutral-coloured anodised aluminium track is used to complement all door colour options, so you won't have to stock a different track for every door colour.



### Simple on-site adjustment

Aspect doors feature a large clearance around door leaves, allowing easy on-site adjustment for hassle-free installations. Butt hinges are also adjustable, providing greater tolerances when fitting the leaves. It means all doors can be fabricated at the same time, since adjustments can be made on site to ensure a precise fit.

### Minimal mess and waste

The slim-stepped outer frame reduces the amount of plaster cutback required on site, speeding up installations and generating minimal dust and waste.

### Hassle-free handling and transportation

Adjustable roller sets allow the doors to be easily jacked or lowered into position on site. The outerframe can also be

mechanically jointed together on site, so the whole unwieldy frame does not have to be delivered in one piece. That makes transportation and handling much simpler and safer.

### Snag-free hinge fitting

All hinges positively locate into the steel reinforcing for a strong, secure finish.

### Dual compatibility gasket slots

Combined wool-pile and gasket slots give you the freedom to choose the type of seal required for each job. Both types of seal fit into the standard slot, so they are easily interchangeable.

# INSTALLATION

HAS NEVER BEEN SIMPLER





**aspect®**

## A WIDE CHOICE OF COLOURS & HARDWARE FINISHES

### Colours to frame the view

Like all Eurocell PVC-U products, Aspect comes with an exact colour-match guarantee. That means the colour is precisely matched to all Eurocell window, door and conservatory roof products, creating a co-ordinated, consistent look across any property.

A range of external colours is available to complement existing architectural style, as well as a choice of hardware colours.

Aspect has a white internal finish as standard, to maintain a bright, fresh interior, with some colours available with colour both sides from stock.

### Up to 10-year guarantee

Aspect bi-fold door profiles are guaranteed for ten years, and door furniture is guaranteed for five years. That means you can give your customers the assurance of a robust, well-designed, precision-made product that's built to last.

### FRAME COLOURS



**ADDITIONAL COLOURS AND SPECIFICATIONS ARE MADE TO ORDER ON EXTENDED LEAD TIMES**



## HARDWARE COLOURS

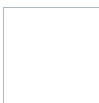

WHITE



BLACK



CHAMPAGNE



SATIN SILVER



SILVER GREY



BRIGHT CHROME





# DOOR CONFIGURATIONS

## ASPECT BI-FOLD DOORS



**4**

Total  
number  
of leaves

**2**

Number  
of leaves  
folding left

**2**

Number  
of leaves  
folding right

All options are available with inward or outward opening doors.

Extra leaves and additional configurations can be chosen, up to the maximum width of six metres.

For spans of more than six metres, multiple doors can be butt-jointed. A project assessment by a qualified structural engineer will be required.

# MULTIPLE OPTIONS AVAILABLE

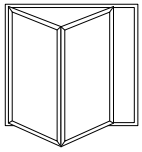

**2-2-0**  
(2-0-2 available)

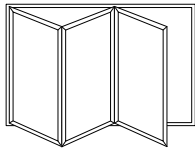

**3-3-0**  
(3-0-3 available)

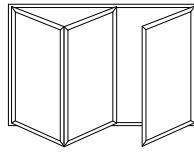

**3-2-1**  
(3-1-2 available)

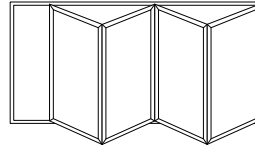

**4-0-4**  
(4-4-0 available)

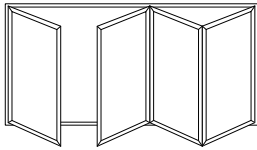

**4-1-3**  
(4-3-1 available)

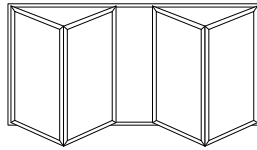

**4-2-2**

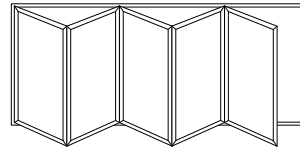

**5-5-0**  
(5-0-5 available)

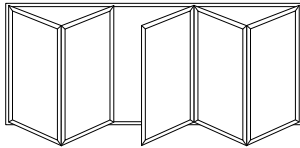

**5-2-3**  
(5-3-2 available)

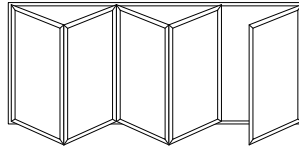

**5-4-1**  
(5-1-4 available)

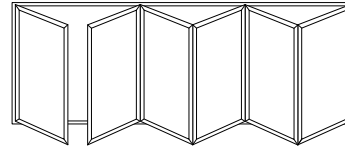

**6-1-5**  
(6-5-1 available)

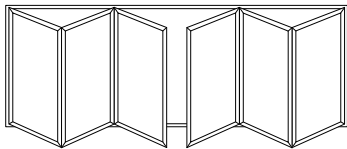

**6-3-3**

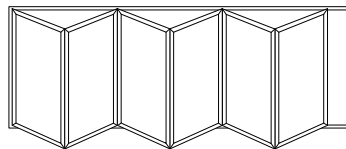

**6-6-0**  
(6-0-6 available)

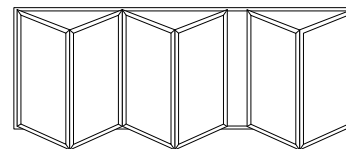

**6-4-2**  
(6-2-4 available)

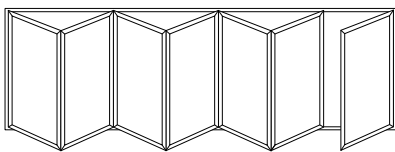

**7-6-1**  
(7-1-6 available)

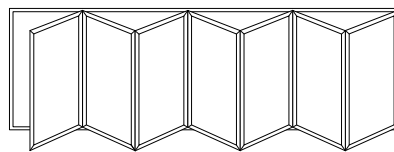

**7-0-7**  
(7-7-0 available)

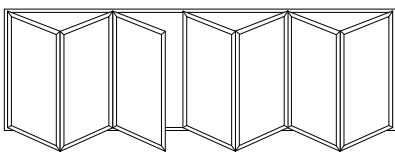

**7-3-4**  
(7-4-3 available)

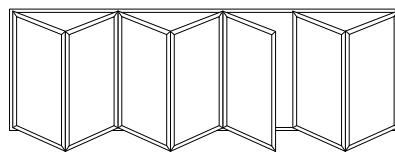

**7-5-2**  
(7-2-5 available)



# TECHNICAL INFORMATION

## ASPECT BI-FOLD DOORS

### THRESHOLDS

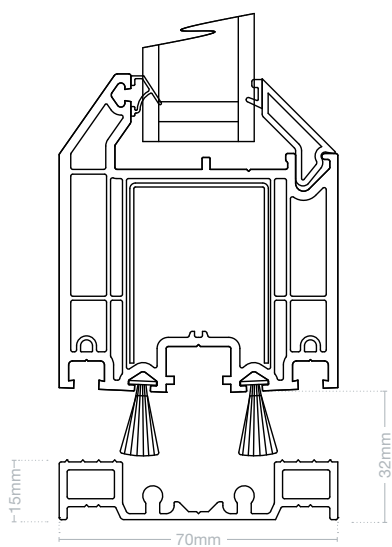

Internal room divider

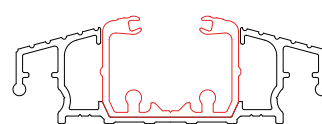

Tray only threshold

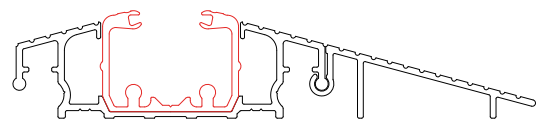

Single ramp threshold

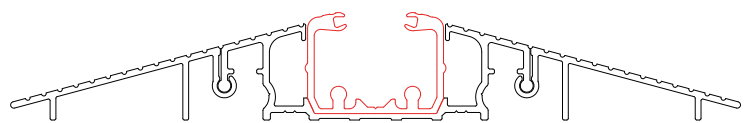

Double ramp threshold (Part M compliant)



# CROSS SECTIONS

## Horizontal

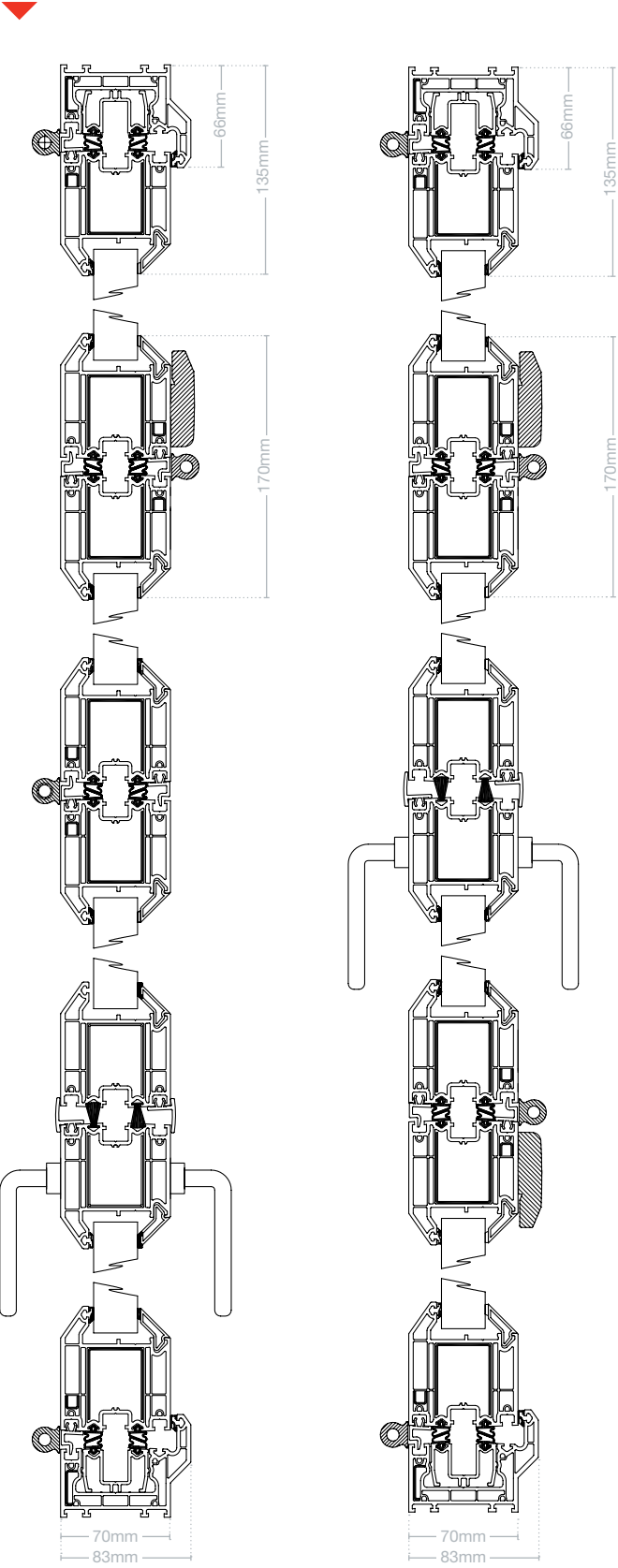

## Vertical

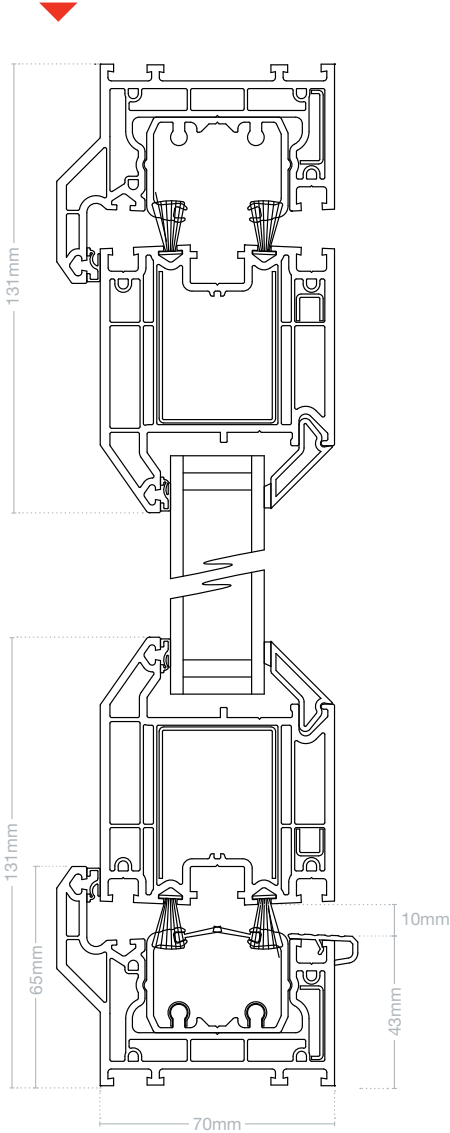

# TECHNICAL INFORMATION

## SYSTEM COMPONENTS

### MAIN PROFILES

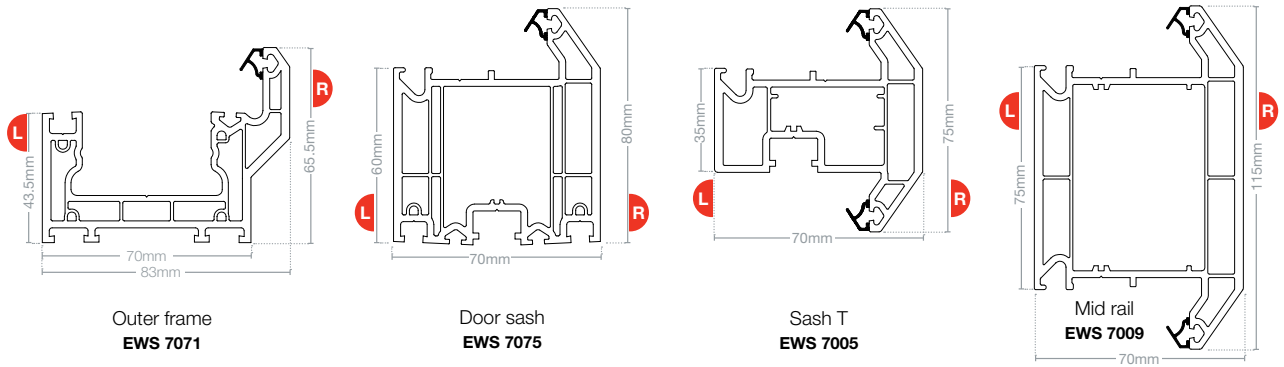

### HARDWARE

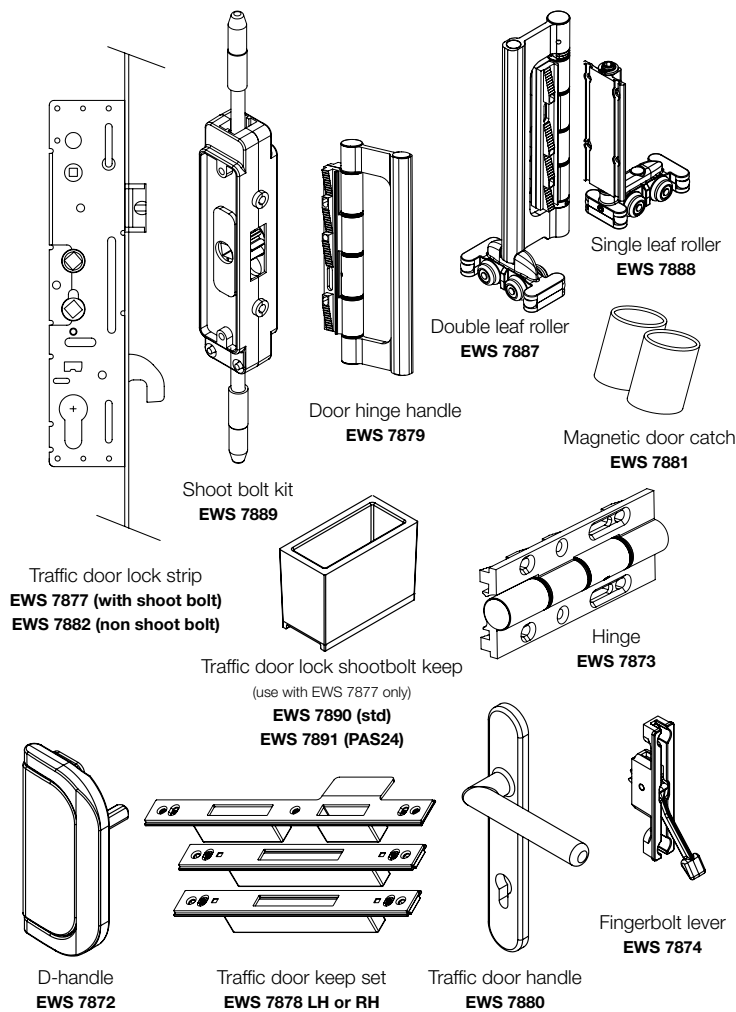

### ALUMINIUM EXTENSIONS

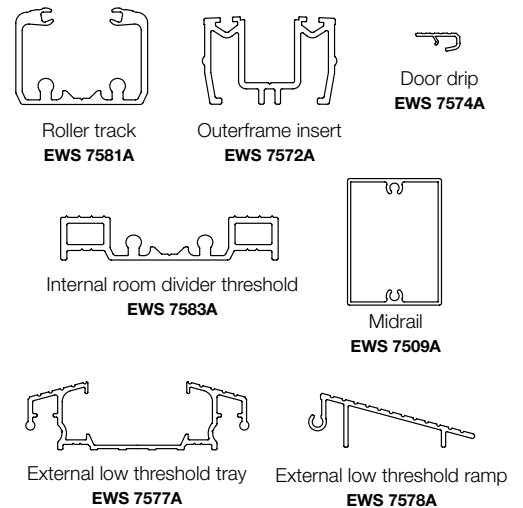

### TRIMS & BEADS

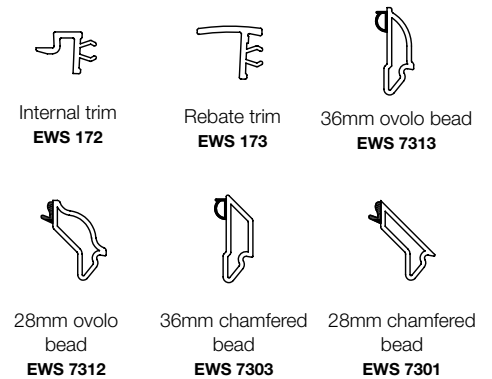

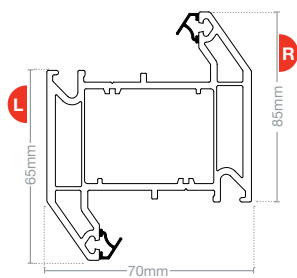

Intermediate transom Z  
**EWS 7023**

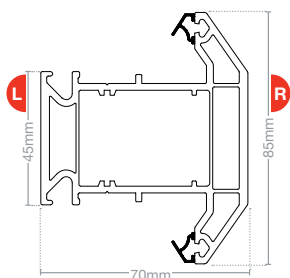

Intermediate transom T  
**EWS 7022**

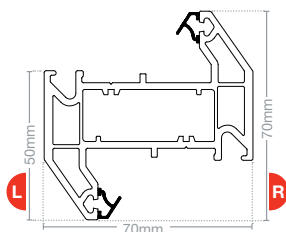

Transom Z  
**EWS 7003**

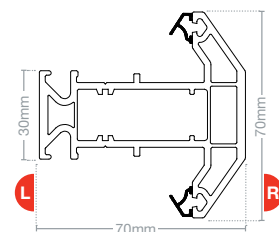

Transom T  
**EWS 7002**

**STEEL REINFORCEMENTS**

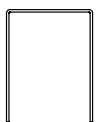

Aspect door sash reinforcement  
**EWS 7677S**  
pre-punched



Intermediate transom Z & T reinforcement  
**EWS 622S**

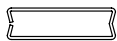

Transom Z & T reinforcement  
**EWS 7621S**



Aspect door sash hinge reinforcement  
**EWS 7676S**



Aspect outerframe hinge reinforcement  
**EWS 7671S**



Stainless steel track  
**EWS 7672S**

**ANCILLARIES**

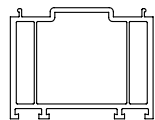

50mm frame extension  
**EWS 126**



40mm butt joint trim  
**EWS 123**

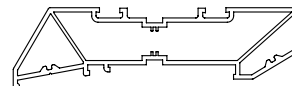

Head vent  
**EWS 135**



'T' capping section  
**EWS 107**

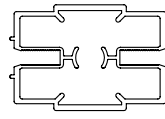

40mm butt joint  
**EWS 528A**

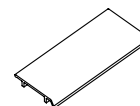

Clip-in glazing platform  
**EWS 7203**

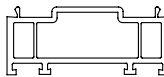

25mm frame extension  
**EWS 106**

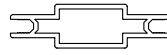

Butt joint  
**EWS 510A**



Overhead vent insert  
**60A621**

**WEATHER SEALS**



Sash gasket  
**EWS 7475G**



Wool pile  
**EWS 7471 GWP**



Roller track brushpile  
**EWS 7472G**



Repair gasket  
**EWS 7402G**

**PVC-U TI'S**



For use with 7002 and 7003  
**EWS 801P**

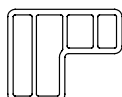

For use with 7005  
**EWS 805P**

**CILLS**

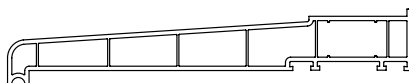

225mm cill  
**AC 225**

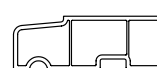

85mm cill  
**AS 85**

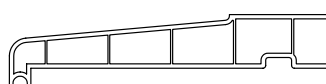

180mm cill  
**AC 180**

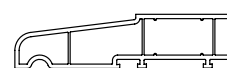

125mm cill  
**AC 125**

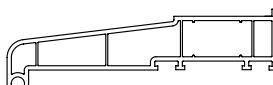

150mm cill  
**AC 150**



Cill reinforcement  
**UNS 5821P**



Cill reinforcement  
**CR 27P**





aspect®

FRENCH & RESIDENTIAL DOORS – AVAILABLE NOW

### Get more from the Aspect profile system

The slim and stylish looks of Aspect panoramic doors has proven to be a hit with homeowners, so why not give them something more? The Aspect profile system can also be used to fabricate contemporary French and entrance doors.

#### French doors

With no dummy mullion and super slim sight lines, Aspect French doors are a premium take on this classic door style. And if you already stock the Aspect profile system and hardware components, you can start fabricating it right away.

#### Entrance doors

These fully glazed doors are designed for simple, fast and accurate fabrication and fitting. Designed to match the Aspect panoramic and French doors aesthetic perfectly, you can offer your customers a seamless solution.





## CASE STUDY

### HOLLAND PARK ZERO CARBON DEVELOPMENT

Eurocell fabricator Victoria Windows and Doors has supplied Aspect bi-fold doors to an award winning zero-carbon development at Holland Park in Exeter. The developer, Heritage New Homes, won Development of the Year South in 'The Bricks' Local Authority Building Control Warranty Awards 2014.

Heritage New Homes designed the Holland Park properties – a development of 40 luxury homes – to satisfy Zero Carbon Emission standards.

Aspect from Eurocell was specified because it was the only PVC-U bi-fold door system in the UK to gain BBA (British Board of Agreement). The larger properties have two sets of bi-fold doors, including a back and side wall arrangement to create stunning panoramic corner views across the gardens. Aspect French doors were installed on the smaller semi-detached properties.

Anthracite Grey was specified, offering a striking contrast to the timber cladding and white render of the exteriors, whilst

the white internal finish complements the light, bright, neutral interiors of the luxury homes.

Being able to source all products required from Victoria Windows and Doors in perfectly co-ordinated Eurocell colours created a better aesthetic. It also allowed the developer to save time and money thanks to the simpler sourcing operation – a factor taken into account by the judges when considering how site activity was managed and co-ordinated.

“Whilst designing the development, the windows and doors were a very important factor for us as they have a significant impact on the energy efficiency and aesthetics of a home”

**Guy Oliver**

Director, Heritage New Homes



*All together better*

For more information about the **aspect®** bi-fold door system from Eurocell, call our customer services team on **0800 988 3047**, or visit **[eurocell.co.uk/aspect](http://eurocell.co.uk/aspect)**

Eurocell plc, Fairbrook House, Clover Nook Road, Alfreton, Derbyshire DE55 4RF



**[eurocell.co.uk](http://eurocell.co.uk)**